

Basic Instructions

These instructions are for both Small and Large Tassel Makers.

Part names

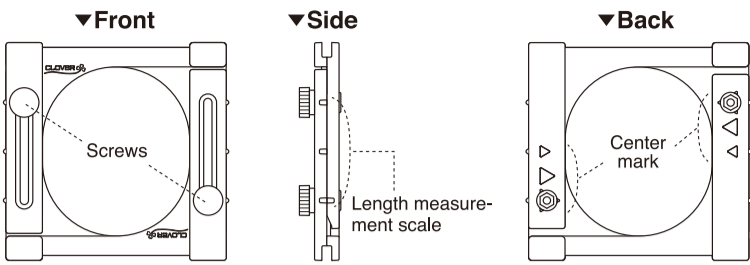

What you'll need

- Thread *-1 (①~④)
- Paper (⑤)
- Scissors
- Ruler
- Adhesive tape

○ Option: Comb
 (It will come in handy to untangle and spread out the threads of tassel.)

- ① Thread for tassels
- ② Strand to tie the center: approx. 12 in. (30 cm)
 (hard-to-break thread, even when firmly tied)
- ③ Strand to wind around the neck: approx. 16 in. (40 cm)
- ④ Cord * -2
- ⑤ Paper (Used to cut the edges of the threads even.)
 ▼ Finished size: 1-3/16 in. (3 cm)

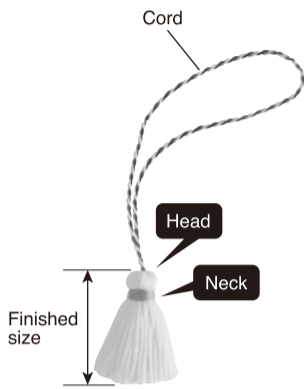
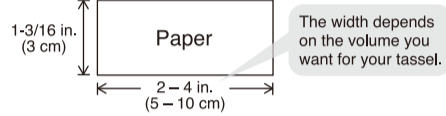

*-1: It's advisable to use hard-to-break, consistent threads like embroidery thread No.25, No.5, or woolen yarn of medium thickness.
 In these instructions, embroidery thread No.25 with 6 strands are used for threads ①, ② and ③.
 *-2: Tie the cord in half to establish the length desired.

Before starting...

- In these instructions, embroidery thread No.25 with 6 strands is used to create a 1-3/16 in. (3 cm) tassel when finished.
- According to the length or the kind of thread you choose, the amount of material you need and the number of times you wind it will change. Please make adjustments according to your preferences.

Variations on the final size

To change the size: loosen the two screws, move along the length measurement scale to the desired size and tighten the screws.

Small maker

Finished sizes:
 1-3/16 – 2 in.
 (3 – 5 cm)

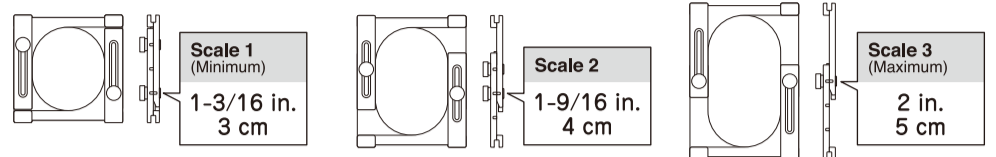

★ To create a tassel of less than 1-3/16 in. (3 cm), adjust the scale to the minimum and then trim the thread to the desired length.

Large maker

Finished sizes:
 2-3/8 – 4 in.
 (6 – 10 cm)

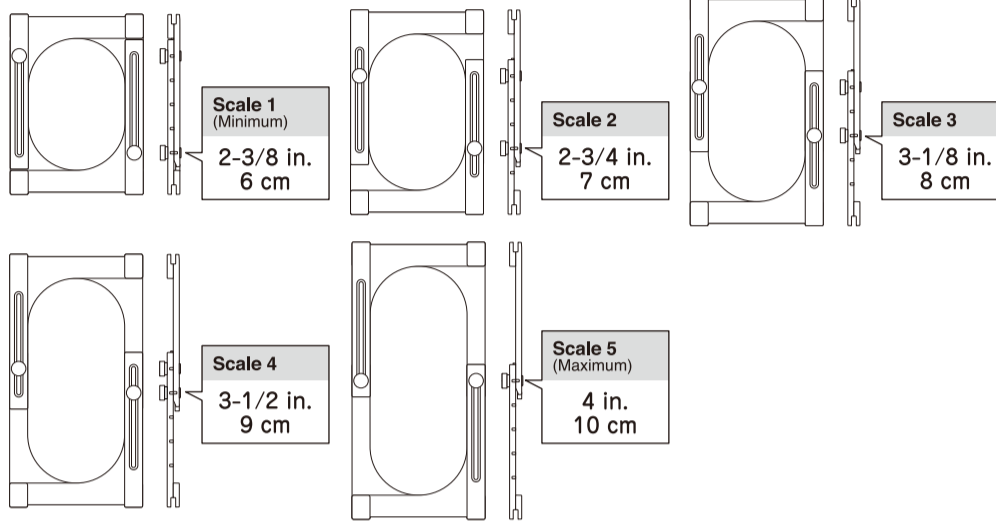

Making the tassel

1 Set the Tassel Maker to the size of the tassel you want to create. Put the Tassel Maker facing down and place the thread as it is shown on the picture.

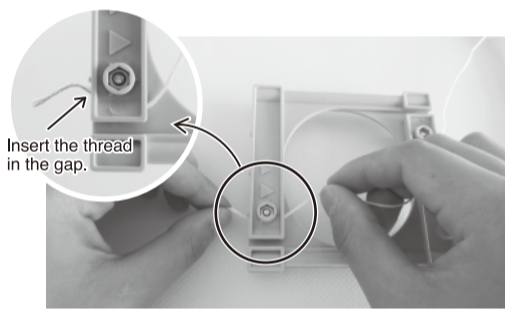

If the thread is too thick or thin to be inserted in the gap, do not use force; instead, start winding it from the center.

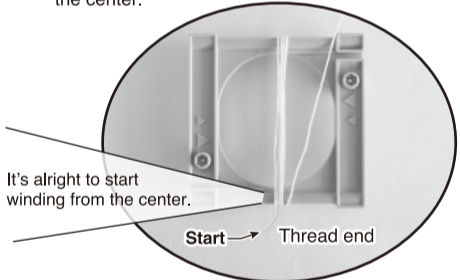

2 Wind the thread as many times as necessary around the center of the Tassel Maker. Place the end of the thread in the gap on the opposite side and trim it.

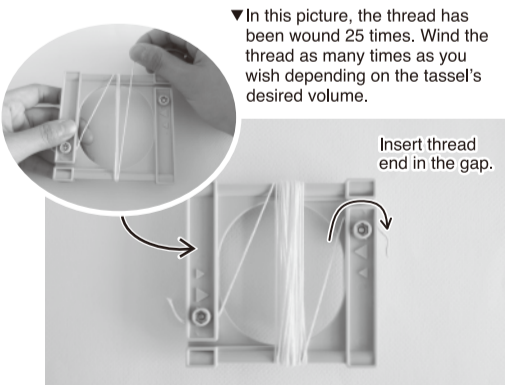

3 Put the knot of the cord in the center and push it inside the bundle.

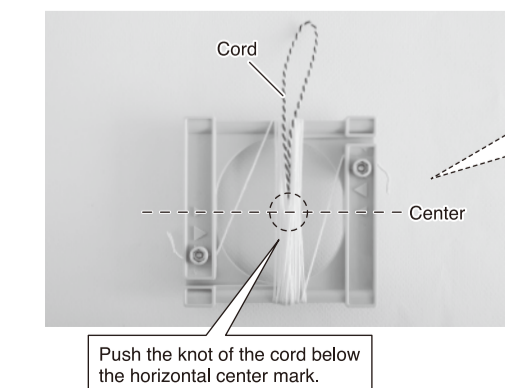

4 Using the strand to tie the center, with the center mark as reference, tie the bundle firmly so the cord does not come out.

★ The strand used in this picture is darker so it can clearly be seen. In your project, use a strand of similar color.

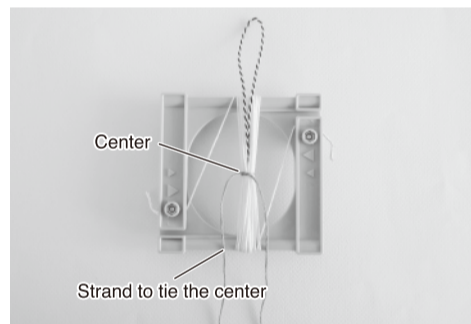

5 With the Tassel Maker facing up, tie firmly two knots around the tassel so they don't come undone and cut the extra strand at the end.

★ If you think it's not securely tied, repeat steps 4 and 5.

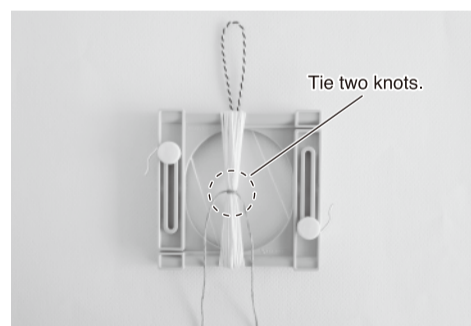

Center mark

To adjust the scale for the tassel you want to create, you can find the approximate center using the triangles on the back of the Tassel Maker or the screws.

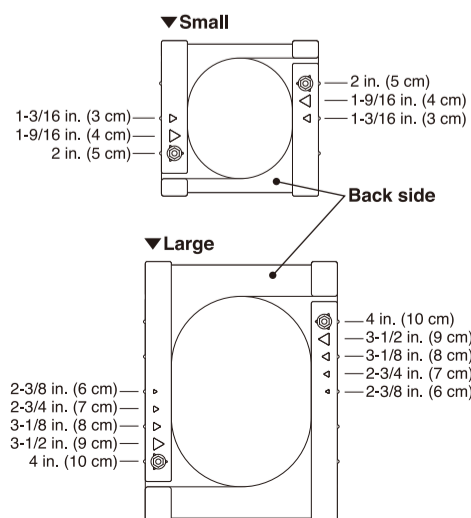

6 Hold the center. Insert the tip of the scissors in the groove and cut through both ends of the loops.

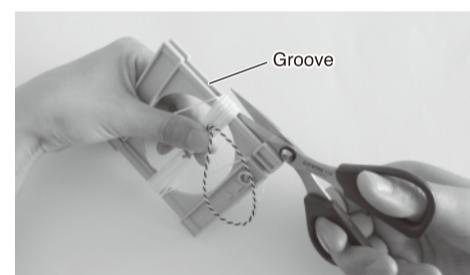

7 Place the loop of the cord up and let the upper threads of the bundle hang evenly as part of the tassel, allowing the cord to stand in the center as shown in the picture.

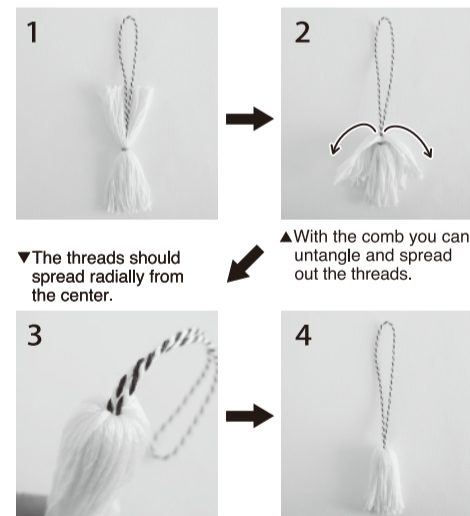

▼ The threads should spread radially from the center.
 ▲ With the comb you can untangle and spread out the threads.

Making the head of the tassel

★ In the picture a strand of a different color is used for clarity.

1 The threads smoothed out, make a loop with a strand you kept for the neck as shown in the picture.

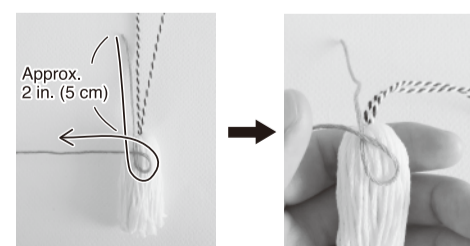

2 Holding the head of the tassel with the threads smoothed out and keeping the loop of the strand in place, wind the long end of the strand clockwise several times around the tassel.

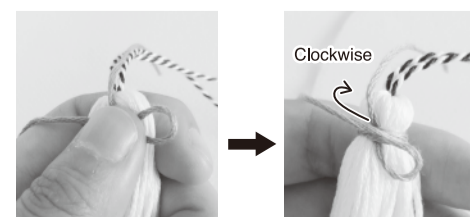

The pictures show how to make a small tassel.

3 The point of intersection should be hidden, so keep winding as many times as necessary. When you finished winding, pass the long end of the strand through the loop and pull.

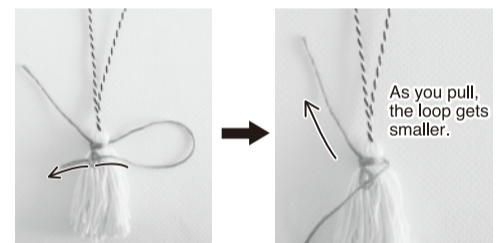

4 Pull firmly both ends of the strand.

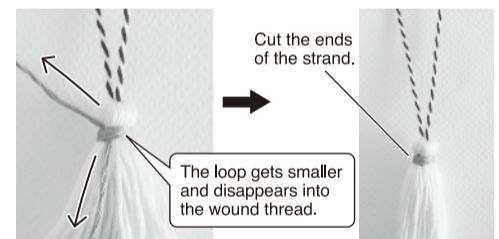

Finishing

Wrap paper around the tassel and tape it. Adjust the paper so that the edge is even with the shortest strand. Cut the threads that protrude out of the paper to create the shape of the tassel.

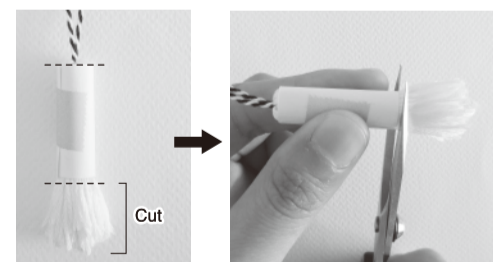

Remove the paper and you are done!



Whether it's with beads or ribbons, there are so many ways to create fun tassels!

